

MBR20100CT ... MBR20200CT	I_{FAV} = 2 x 10 A	V_{RRM} = 100...200 V
High Temperature Schottky Barrier Rectifier Diodes	V_{F100V} < 0.85 V	I_{FSM} = 130/150 A
Hochtemperatur Schottky-Gleichrichterdiodes	T_{jmax} = 175°C	

Version 2018-04-20

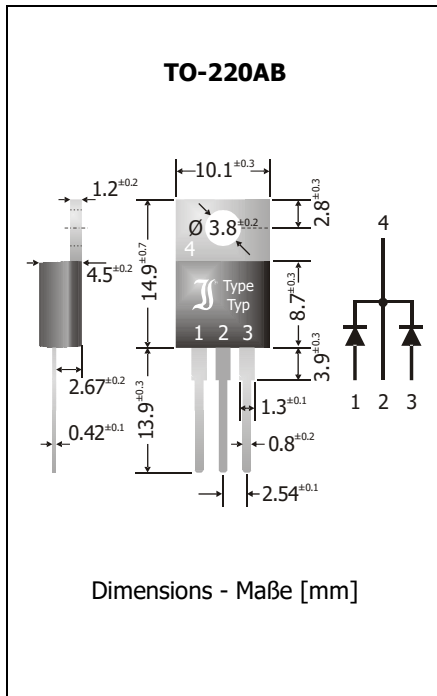

Typical Applications

Output Rectification in DC/DC Converters and Power Supplies
Polarity Protection
(For free-wheeling diodes and power tool switches, Protectifiers® are the better choice, e. g. KT20A150)
Commercial grade ¹⁾

Features

High reverse voltage
Very high frequency operation
Common cathode
Compliant to RoHS, REACH, Conflict Minerals ¹⁾

Mechanical Data ¹⁾

Packed in tubes/cardboards	50/1000
Weight approx.	2.2 g
Case material	UL 94V-0
Solder & assembly conditions	260°C/10s MSL N/A

Typische Anwendungen

Ausgangsgleichrichtung in DC/DC-Wandlern und Netzteilen
Verpolschutz (Für Freilaufdioden und Elektrowerkzeugschalter sind Protectifiers® die bessere Alternative, z. B. KT20A150)
Standardausführung ¹⁾

Besonderheiten

Hohe Sperrspannung
Betrieb bei sehr hohen Frequenzen
Gemeinsame Kathode
Konform zu RoHS, REACH, Konfliktmineralien ¹⁾

Mechanische Daten ¹⁾

Verpackt in Stangen/Kartons	Gewicht ca.
	Gehäusematerial
Löt- und Einbaubedingungen	

Maximum ratings ²⁾

Grenzwerte ²⁾

Type Typ	Repetitive peak reverse voltage Periodische Spitzensperrspannung V _{RRM} [V]	Surge peak reverse voltage Stoßspitzensperrspannung V _{RSM} [V]
MBR20100CT	100	100
MBR20150CT	150	150
MBR20200CT	200	200

Max. average forward rectified current Dauergrenzstrom in Einwegschaltung	T _C = 125°C ³⁾	I _{FAV}	10 A ⁴⁾ 20 A ⁵⁾
Repetitive peak forward current Periodischer Spitzenstrom	f > 15 Hz T _C = 125°C ³⁾	I _{FRM}	30 A ⁴⁾
Peak forward surge current (half sine-wave) Stoßstrom in Fluss-Richtung (Sinus-Halbwelle)	50 Hz (10 ms) 60 Hz (8.3 ms)	I _{FSM}	130 A ⁴⁾ 150 A ⁴⁾
Rating for fusing – Grenzlastintegral	t < 10 ms	i ² t	80 A ² s ⁴⁾
Junction temperature – Sperrschichttemperatur Storage temperature – Lagerungstemperatur		T _j T _S	-50...+175°C -50...+175°C

1 Please note the [detailed information on our website](#) or at the beginning of the data book
Bitte beachten Sie die [detaillierten Hinweise auf unserer Internetseite](#) bzw. am Anfang des Datenbuches
2 T_A = 25°C unless otherwise specified – T_A = 25°C wenn nicht anders angegeben
3 Measured at heat flange – Gemessen an der Kühlfahne
4 Per diode – Pro Diode
5 Per device (parallel operation) – Pro Bauteil (Parallelbetrieb)

Characteristics
Kennwerte

Type Typ	Forward voltage Durchlass-Spannung			Forward voltage Durchlass-Spannung		
	V_F [V] ¹⁾	@ I_F [A]	@ T_j	V_F [V] ¹⁾	@ I_F [A]	@ T_j
MBR20100CT	< tbd	5	25°C	< 0.85	10	25°C
MBR20150CT	< tbd	5	25°C	< 0.90	10	25°C
MBR20200CT	< tbd	5	25°C	< 0.95	10	25°C

Leakage current Sperrstrom	$T_j = 25^\circ\text{C}$ $T_j = 100^\circ\text{C}$	$V_R = V_{RRM}$	I_R	< 50 μA ¹⁾ typ. 1 mA ¹⁾
Typical junction capacitance Typische Sperrschichtkapazität		$V_R = 4\text{ V}$	C_j	500 pF ¹⁾
Thermal resistance junction to case Wärmewiderstand Sperrschicht – Gehäuse			R_{thC}	< 1.5 K/W ^{2,3)}

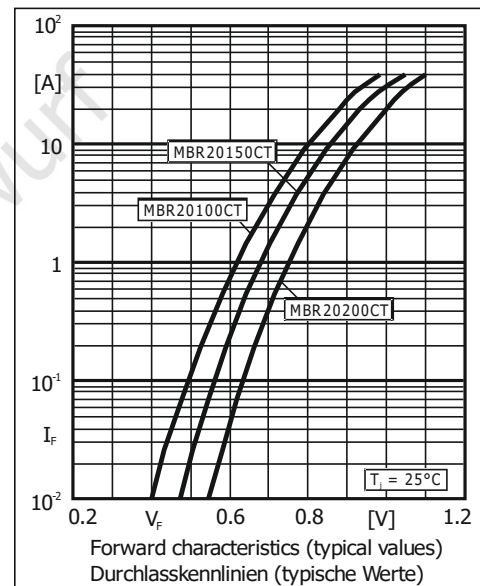
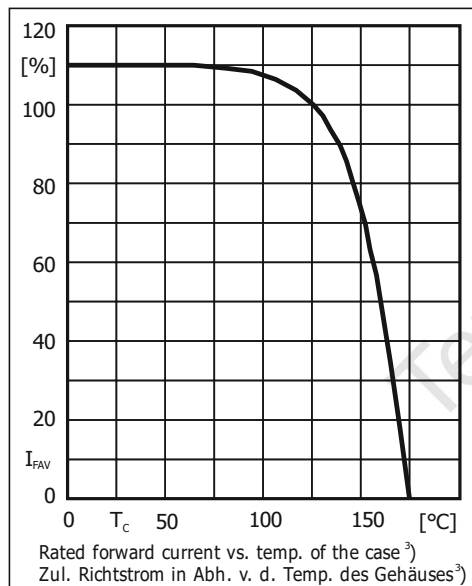

Disclaimer: See data book page 2 or [website](#)
Haftungsausschluss: Siehe Datenbuch Seite 2 oder [Internet](#)

1 Per diode – Pro Diode
 2 Per device (parallel operation) – Pro Bauteil (Parallelbetrieb)
 3 Measured at heat flange – Gemessen an der Kühlfahne