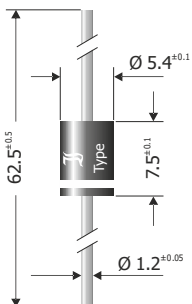
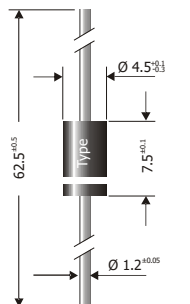
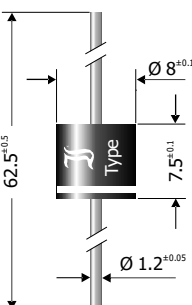
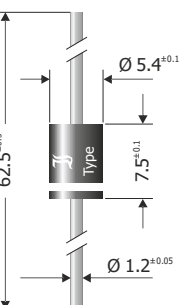

Produktänderungsmitteilung *Product Change Notification*

Titel Title	Umstellung von Schottky-Dioden auf Chip der 3. Generation (-3G) <i>Transition of Schottky Diodes to 3rd Generation Chip (-3G)</i>
Typen Types	1. SMD SK32SMA, SK33SMA, SK34SMA 2. – 8. Axial SB1220, SB1230, SB1240, SB1520, SB1530, SB1540, SBX2030, SBX2040, SBX2045, SBX2530, SBX2540(R), SBX3030, SBX3040(R), 15SQ045, 20SQ040, 20SQ045
Grund der Änderung	Die Schottky-Chiptechnologie der 3. Generation erlaubt eine Reduktion der Chipfläche bei unveränderten/teilweise verbesserten elektrischen Eigenschaften. Dies bringt Vorteile im Hinblick auf niedrigere Sperrschichtkapazitäten, niedrigere Sperrströme und ermöglicht (wo sinnvoll) den Aufbau in kleineren Gehäusebauformen.
Reason of Change	<i>The 3rd Generation Schottky chip technology allows for reduction in die size at unchanged/partly improved electrical characteristics. This provides advantages like lower junction capacities, lower leakage currents and offers (where applicable) assembly in smaller package outlines.</i>
Zustimmung	Diese PCN wird 30 Tage nach Ablauf des obigen Datums als akzeptiert betrachtet. Spezielle Vorgehensweisen können innerhalb dieses Zeitraums vom Kunden schriftlich vorgeschlagen werden. Diotec wird diese prüfen und dazu Stellung nehmen.
Acceptance	<i>This PCN will be considered approved 30 days after above given date. Specific proceedings might be proposed within this period by the customer in writing. Diotec will check it and provide a statement.</i>
Art der Änderung Type of Change	<input type="checkbox"/> Major (Änderung in Aussehen, Abmessung oder Funktion <i>Change in form, fit or function</i>) <input type="checkbox"/> Minor

1. SMD	Bisher Current	Neu New
Mechanisch Mechanical	Keine Änderung <i>No change</i>	
Elektrisch Electrical	$V_F < 0.5V$ at 3A $I_R < 100\mu A$ at 20/30/40V C_j typ. 250pF at 4V	$V_F < 0.5V$ at 3A $I_R < 100\mu A$ at 40V C_j typ. 90pF at 4V
Verpackungseinheit Packaging Unit	Keine Änderung <i>No change</i>	
Bestell-Bezeichnung Ordering Code	SK32SMA, SK33SMA, SK34SMA	SK34SMA-3G
Lieferbarkeit Availability	Letzte Bestellmöglichkeit <i>Last time buy</i>	31.12.2018 sofort <i>immediately</i>
	Letzte Lieferung <i>Last time shipment</i>	28.02.2019 sofort <i>immediately</i>

2. Axial	Bisher Current	Neu New	
Mechanisch Mechanical [mm]	<p>Ø 5.4 x 7.5</p> 	<p>~ DO-201</p> 	
	<p>$V_F < 0.55V$ at 12A $I_R < 500\mu A$ at 40V C_j typ. 720pF at 4V</p>	<p>$V_F < 0.55V$ at 12A $I_R < 200\mu A$ at 40V C_j typ. 510pF at 4V</p>	
Verpackungseinheit Packaging Unit	1250	1700	
Bestell-Bezeichnung Ordering Code	SB1220, SB1230, SB1240	SB1240-3G	
Lieferbarkeit Availability	Letzte Bestellmöglichkeit Last time buy	31.12.2018	sofort <i>immediately</i>
	Letzte Lieferung Last time shipment	28.02.2019	sofort <i>immediately</i>

3. Axial	Bisher Current	Neu New	
Mechanisch Mechanical [mm]	<p>Ø 8 x 7.5</p> 	<p>Ø 5.4 x 7.5</p> 	
	<p>$V_F < 0.55V$ at 15A $I_R < 500\mu A$ at 40V C_j typ. 1000pF at 4V</p>	<p>$V_F < 0.55V$ at 15A $I_R < 200\mu A$ at 40V C_j typ. 720pF at 4V</p>	
Verpackungseinheit Packaging Unit	500	1250	
Bestell-Bezeichnung Ordering Code	SB1520, SB1530, SB1540	SB1540-3G	
Lieferbarkeit Availability	Letzte Bestellmöglichkeit Last time buy	31.12.2018	sofort <i>immediately</i>
	Letzte Lieferung Last time shipment	28.02.2019	sofort <i>immediately</i>

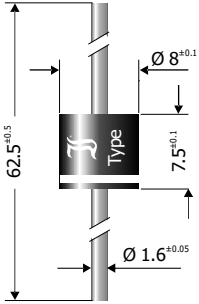
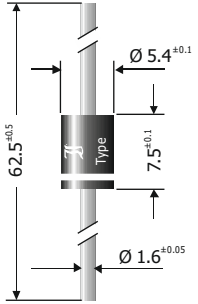
4. Axial	Bisher Current	Neu New	
Mechanisch Mechanical [mm]	Ø 8 x 7.5 (Low R_{thL}) 	Ø 5.4 x 7.5 (Low R_{thL}) 	
	Elektrisch Electrical $V_F < 0.59V$ at 20A $I_R < 500\mu A$ at 40V C_j typ. 1000pF at 4V	$V_F < 0.55V$ at 20A $I_R < 200\mu A$ at 40V C_j typ. 720pF at 4V	
Verpackungseinheit Packaging Unit	500	1250	
Bestell-Bezeichnung Ordering Code	SBX2030, SBX2040, SBX2045	SBX2040-3G, SBX2045-3G	
Lieferbarkeit Availability	Letzte Bestellmöglichkeit Last time buy	31.12.2018	sofort immediately
	Letzte Lieferung Last time shipment	28.02.2019	sofort immediately

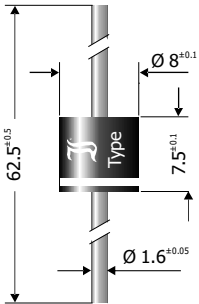
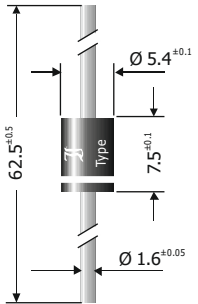
5. Axial	Bisher Current	Neu New	
Mechanisch Mechanical [mm]	Ø 8 x 7.5 (Low R_{thL}) 	Ø 5.4 x 7.5 (Low R_{thL}) 	
	Elektrisch Electrical $V_F < 0.59V$ at 25A $I_R < 500\mu A$ at 40V C_j typ. 1000pF at 4V	$V_F < 0.57V$ at 20A $I_R < 200\mu A$ at 40V C_j typ. 720pF at 4V	
Verpackungseinheit Packaging Unit	500	1250	
Bestell-Bezeichnung Ordering Code	SBX2530, SBX2540(R)	SBX2540-3G(R)	
Lieferbarkeit Availability	Letzte Bestellmöglichkeit Last time buy	31.12.2018	sofort immediately
	Letzte Lieferung Last time shipment	28.02.2019	sofort immediately

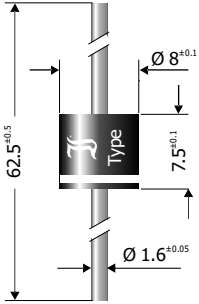
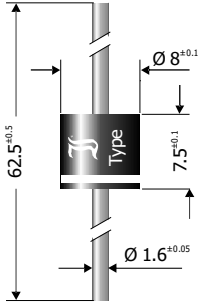
6. Axial	Bisher Current		Neu New
Mechanisch Mechanical [mm]	Ø 8 x 7.5 (Low R_{thL})		Ø 8 x 7.5 (Low R_{thL})
			
Elektrisch Electrical	$V_F < 0.55V$ at 30A $I_R < 500\mu A$ at 40V C_j typ. 1000pF at 4V		$V_F < 0.55V$ at 30A $I_R < 300\mu A$ at 40V C_j typ. 1000pF at 4V
Verpackungseinheit Packaging Unit	500		500
Bestell-Bezeichnung Ordering Code	SBX3030, SBX3040(R)		SBX3040-3G(R)
Lieferbarkeit Availability	Letzte Bestellmöglichkeit Last time buy	31.12.2018	sofort <i>immediately</i>
	Letzte Lieferung Last time shipment	28.02.2019	sofort <i>immediately</i>

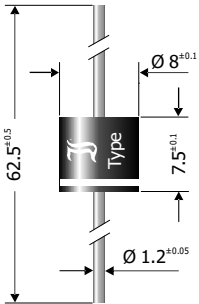
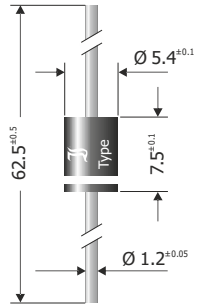
7. Axial	Bisher Current		Neu New
Mechanisch Mechanical [mm]	Ø 8 x 7.5		Ø 5.4 x 7.5
			
Elektrisch Electrical	$V_F < 0.53V$ at 15A $I_R < 300\mu A$ at 40V C_j typ. 800pF at 4V		$V_F < 0.55V$ at 15A $I_R < 200\mu A$ at 40V C_j typ. 720pF at 4V
Verpackungseinheit Packaging Unit	500		1250
Bestell-Bezeichnung Ordering Code	15SQ045		15SQ045-3G
Lieferbarkeit Availability	Letzte Bestellmöglichkeit Last time buy	31.12.2018	sofort <i>immediately</i>
	Letzte Lieferung Last time shipment	28.02.2019	sofort <i>immediately</i>

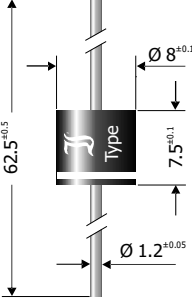
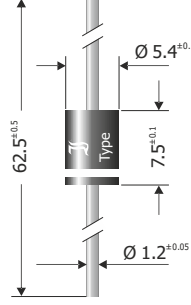
8. Axial	Bisher <i>Current</i>		Neu <i>New</i>
Mechanisch Mechanical [mm]	<p style="text-align: center;">Ø 8 x 7.5</p> 		<p style="text-align: center;">Ø 5.4 x 7.5</p> 
Elektrisch Electrical	$V_F < 0.55V$ at 20A $I_R < 500\mu A$ at 40V C_j typ. 800pF at 4V		$V_F < 0.55V$ at 15A $I_R < 200\mu A$ at 40V C_j typ. 720pF at 4V
Verpackungseinheit Packaging Unit	500		1250
Bestell-Bezeichnung Ordering Code	20SQ040, 20SQ045		20SQ045-3G
Lieferbarkeit Availability	Letzte Bestellmöglichkeit <i>Last time buy</i>	31.12.2018	sofort <i>immediately</i>
	Letzte Lieferung <i>Last time shipment</i>	28.02.2019	sofort <i>immediately</i>